

ENERGIZER L92

AAA

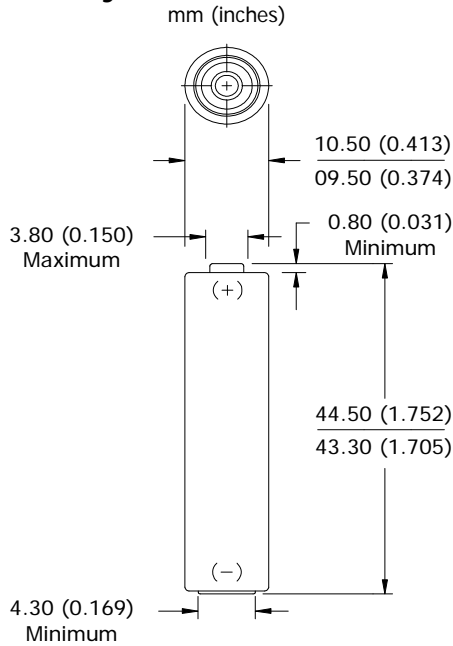

Industry Standard Dimensions



This battery has Underwriters Laboratories component recognition (MH29980)

Specifications

Classification:	"Cylindrical Lithium"
Chemical System:	Lithium/Iron Disulfide (Li/FeS ₂)
Designation:	ANSI 24-LF, IEC-FR03
Nominal Voltage:	1.5 Volts
Typical Weight:	7.6 grams (0.3 oz.)
Typical Volume:	3.8 cubic centimeters (0.2 cubic inch)
Max Discharge:	1.5 Amps Continuous
(single battery only)	2.0 Amps Pulse (2 sec on / 8 sec off)
Typical Li Content:	0.5 grams (0.02 oz.)
Typical IR:	90 to 150 milliohms*
Shelf Life:	15 years at 21°C (90% of rated capacity)
Transportation:	For complete details, please reference:
Global (except US):	Special Provision A45 of the International Air Transport Association Dangerous Goods Regulations
United States:	49 CFR 173.185

* For additional information, please reference the [IR technical white paper](#).

Milliamp-Hours Capacity

Constant Current Discharge to 0.9 Volts at 21°C

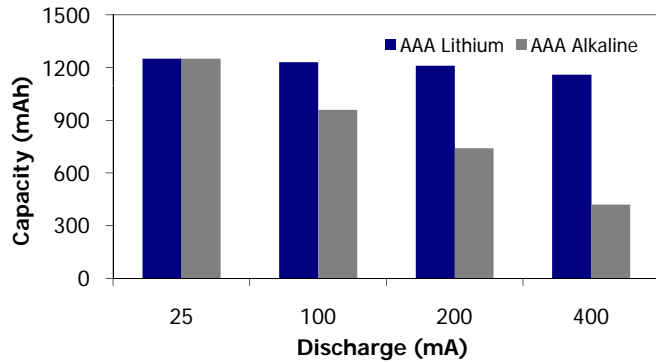

Milliwatt-Hours Capacity at Cold/Room Temperature

Constant Power Discharge to 1.0 Volts at 0°C and 21°C
Recommended Lithium Operating/Storage Temperature: -40°C to 60°C

Cold Temperature (0°C)

Constant Power Discharge

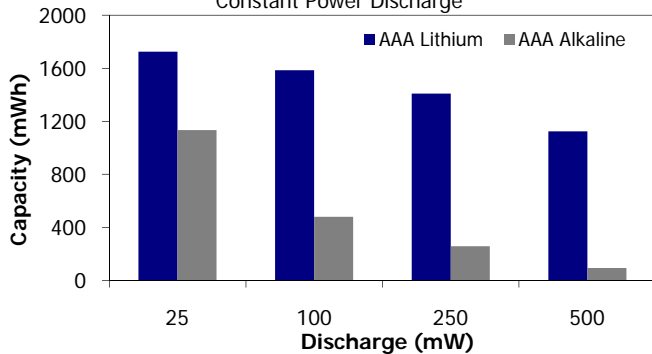

Room Temperature (21°C)

Constant Power Discharge

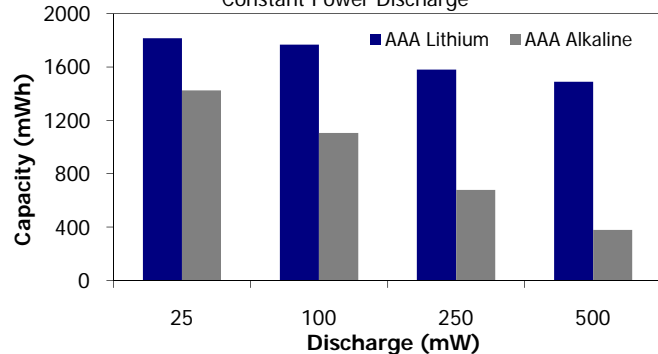

Important Notice

This datasheet contains typical information specific to products manufactured at the time of its publication.
©Energizer Holdings, Inc. - Contents herein do not constitute a warranty.

ENERGIZER L92

AAA

Typical Discharge Curve Characteristics

Constant Current Discharge at 21°C (low and high drains)

Low Drain Performance
50mA Continuous (21°C)

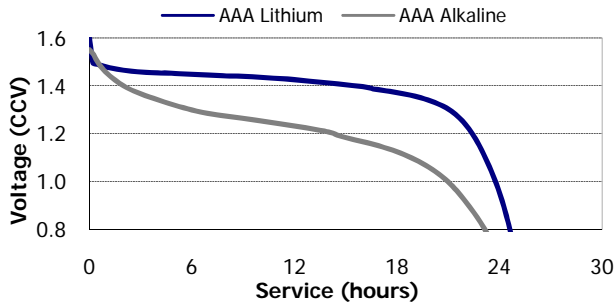

High Drain Performance
600mA Continuous (21°C)

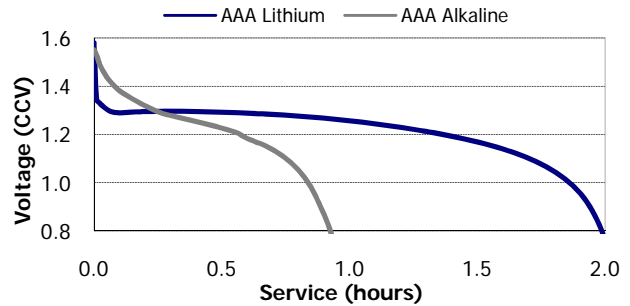

Constant Power Performance

Typical Characteristics to 1.0 Volts (21°C)

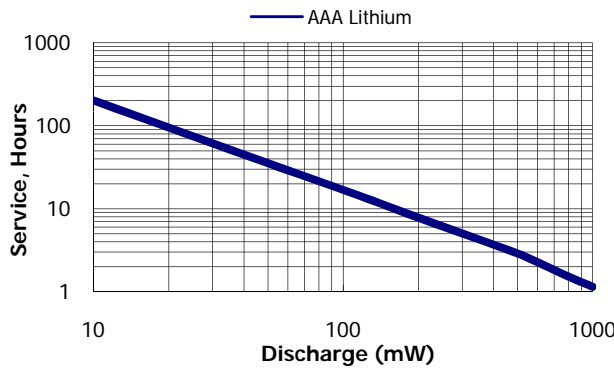

Constant Current Performance

Typical Characteristics to 1.0 Volts (21°C)

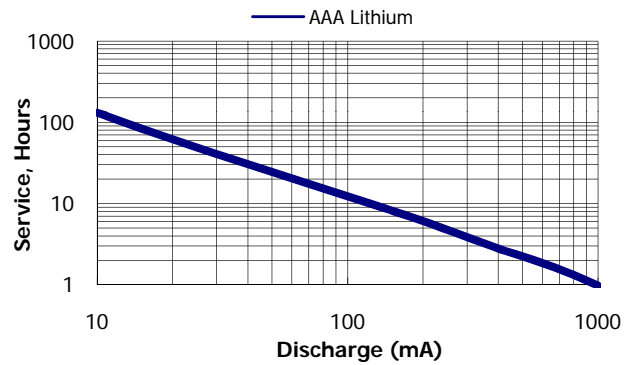

Application Tests (21°C)

ELECTRONIC GAME / DIGITAL AUDIO
100 mA 1 hr/day

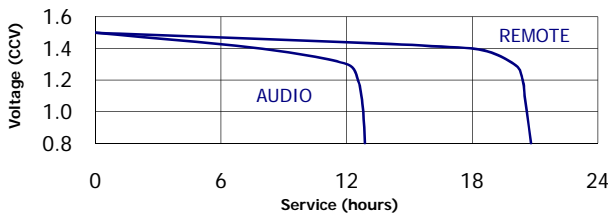

REMOTE
24 ohm 15 sec/min 8 hrs/day

Industry Standard Tests (21°C)

DIGITAL STILL CAMERA (DSC)
.9/.4K mW 2/28 sec 10x per hour

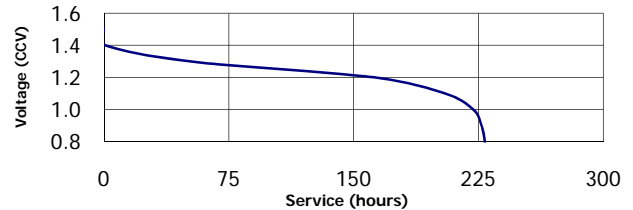

PHOTOFLASH
600 mA 10 sec/min 1 hr/day

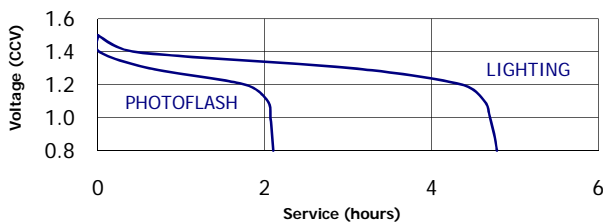

PORTABLE LIGHTING
5.1 ohm LIF

DIGITAL STILL CAMERA (DSC)
1.2/.65 mW 2/.1/27.9 sec 10c per hour

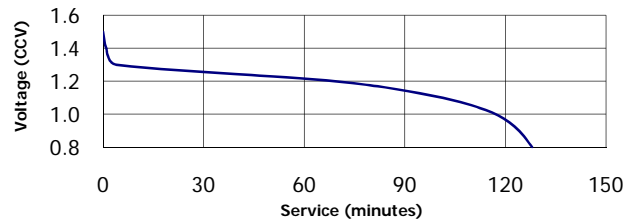

Important Notice

This datasheet contains typical information specific to products manufactured at the time of its publication.
©Energizer Holdings, Inc. - Contents herein do not constitute a warranty.